



McIntosh Laboratory, Inc. 2 Chambers Street Binghamton, New York 13903-2699 Phone: 607-723-3512 www.mcintoshlabs.com

MA352

Integrated Amplifier

Owner's Manual





Important Safety Information is supplied in a separate document “Important Additional Operation Information Guide”

Thank You

Your decision to own this McIntosh MA352 Integrated Amplifier ranks you at the very top among discriminating music listeners. You now have “The Best.” The McIntosh dedication to “Quality,” is assurance that you will receive many years of musical enjoyment from this unit.

Please take a short time to read the information in this manual. We want you to be as familiar as possible with all the features and functions of your new McIntosh.

Please Take A Moment

The serial number, purchase date and McIntosh Dealer name are important to you for possible insurance claim or future service. The spaces below have been provided for you to record that information:

Serial Number: _____

Purchase Date: _____

Dealer Name: _____

Technical Assistance

If at any time you have questions about your McIntosh product, contact your McIntosh Dealer who is familiar with your McIntosh equipment and any other brands that may be part of your system. If you or your Dealer wish additional help concerning a suspected problem, you can receive technical assistance for all McIntosh products at:

McIntosh Laboratory, Inc.
2 Chambers Street
Binghamton, New York 13903
Phone: 607-723-3512
Fax: 607-724-0549

Customer Service

If it is determined that your McIntosh product is in need of repair, you can return it to your Dealer. You can also return it to the McIntosh Laboratory Service Department. For assistance on factory repair return procedure, contact the McIntosh Service Department at:

McIntosh Laboratory, Inc.
2 Chambers Street
Binghamton, New York 13903
Phone: 607-723-3515
Fax: 607-723-1917

Table of Contents

Safety Instructions.....	2
(Separate Sheet).....	Important Additional
	Operation Information Guide
Thank You and Please Take a Moment	2
Technical Assistance and Customer Service.....	2
Table of Contents	2
Important Information.....	3
Unpacking the MA352.....	4-5
General Information	6
Connector and Cable Information	6
Introduction	7
Performance Features	7
Dimensions	8
Installation	9
Connections:	
Rear Panel Connections.....	10
Connecting Components and Loudspeakers.....	11-12
MA352 Switch Power On	13
Remote Control and Front Panel:	
Remote Control Push-buttons	14
How to use the Remote Control.....	15
Front Panel Displays, Controls and Jack	16

Setup Mode:

How to Operate the Setup Mode 17

Setup Functions:

Default Settings	17
Firmware Version	17
Source Input On/Off and Renaming	17-18
Output 2, Passthru	19
Data Port	19
Comm Port Baud Rate.....	20
Remote Control Codes.....	20
IR Sensor.....	20
Power Mode	21
Factory Reset	21

Operation:

How to Operate the MA352 22-25

Trim Functions:

Balance.....	22
Equalizer Mode.....	23
Mono/Stereo Mode	23
Output 1 and 2.....	23-24
Trim Level.....	24
Meter Illumination.....	24
Tube Lights.....	24-25
Information Display Illumination	25
Information Display Activity	25

Reset of the Microprocessors

Specifications and Equalizer Controls

Packing Instructions.....

IMPORTANT!

**INSTRUCTIONS FOR REMOVAL
OF FOAM INSERT OVER THE
VACUUM TUBES PRIOR TO
CONNECTING THE A.C. POWER
SUPPLY CORD, START ON THE
NEXT PAGE.**



Caution: To prevent damage to the MA352 Tubes during shipping, there is a special foam insert surrounding the Tubes of the Integrated Amplifier.

The Foam Insert must be removed from the MA352 before connecting the AC Power Supply Cord to the integrated amplifier.

Failure to do so has the potential of a Fire Hazard, resulting in damage to the MA352 and the surrounding environment.

Follow these instructions for removal of the packing foam before connecting the AC Power Supply Cord to the MA352.

The MA352 has no user serviceable parts, including the tubes. If repairs are needed they must be performed by an authorized McIntosh Service Agency. Follow the steps below to prepare the MA352 for operation:

1. Orient the MA352 so the Front and Top of the Integrated Amplifier is facing you. Refer to figure A.

2. Remove the Warning Sheet and save it with the Shipping Carton for possible future use. Refer to figures A and B.

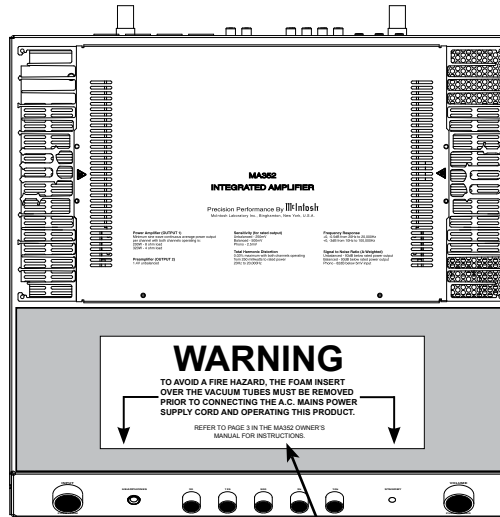

Figure A

Remove the Warning Sheet

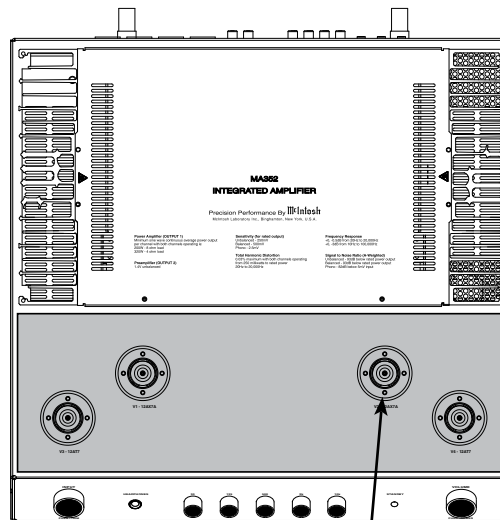

Figure B

Vacuum Tube Shield Covers

3. Carefully lift upright the Foam Insert Vacuum Tube Cover and place it near to the MA352 Integrated Amplifier. Refer to figure C.

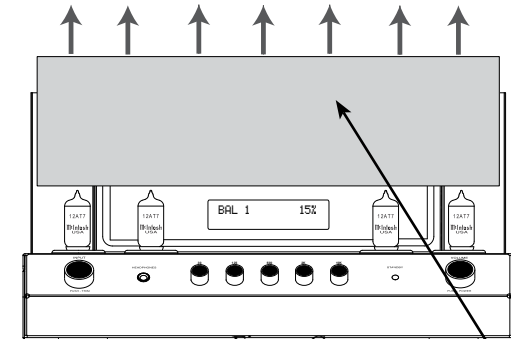

Figure C

Remove the Foam Insert Vacuum Tube Cover

4. Remove from the Foam, the four Vacuum Tube Shield Covers and place them along the side of the MA352 Integrated Amplifier. Save the Foam Insert Vacuum Tube Cover with the Shipping Carton for possible future use. Refer to figure D.

Remove the four Vacuum Tube Shield Covers

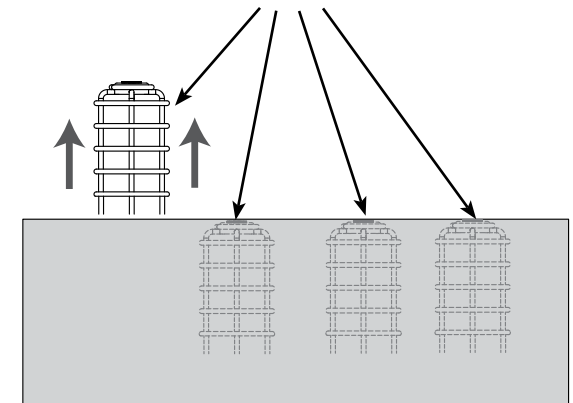

Figure D

WARNING:

The supplied Vacuum Tube Shield Covers must be installed over each of the four Small Vacuum Tubes before the MA352 Integrated Amplifier is connected to AC Power and activated for use!!

Failure to do so has the potential to cause physical harm to human beings and animals.

This could also result in damage to the Vacuum Tubes and the MA352 Internal Circuitry.

It also prevents the potential of a Fire Hazard, resulting in damage to the MA352 and the surrounding environment.

5. The MA352 Integrated Amplifier has four Small Vacuum Tubes that are inserted into special Vacuum Tube Sockets on the Stainless Steel Chassis. Refer to figure E.

Each of the Tube Sockets have four pin openings to accept the Vacuum Tube Shield Covers. Refer to figure F.

Carefully install the Vacuum Tube Shield Covers into each of the Vacuum Tube Sockets orienting the Shield so the “Mc” on top of the Shield is facing forward. Refer to figures G and H.

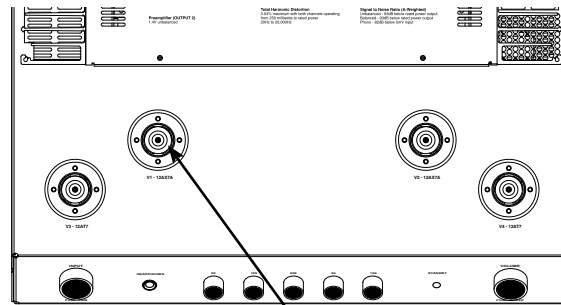

Figure E

Special Vacuum Tube Sockets

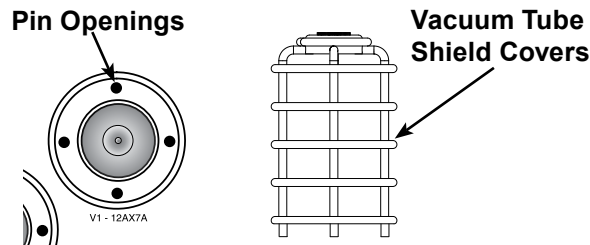

Figure F

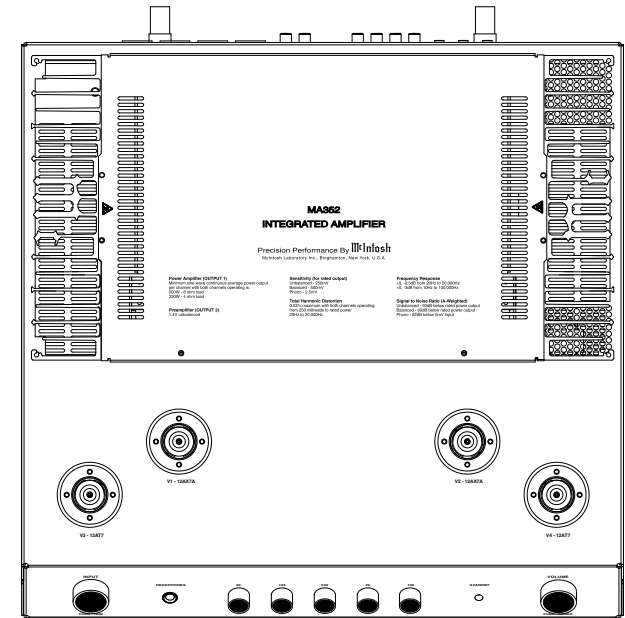

Figure G

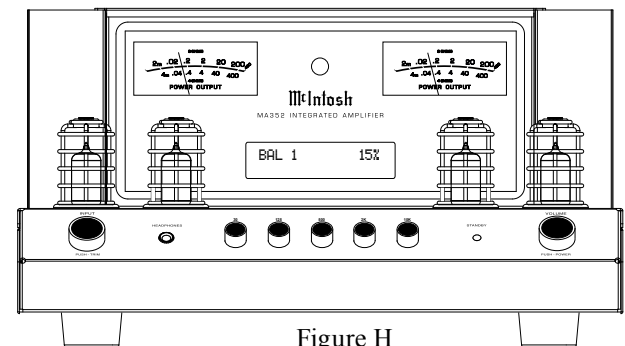



Figure H

General Information

1. For additional connection information, refer to the owner's manual(s) for any component(s) connected to the MA352.
2. Apply AC Power to the MA352 and other McIntosh Component(s) only after all the system components are connected together. Failure to do so may cause a malfunction of system operations as the Micro-processor's Circuitry inside the components is active when AC Power is applied.
3. **The MA352 includes an Auto Off Power Save Feature and the default setting is enabled.** For additional information including how to disable it, refer to page 21.
4. When Power Amplifier Protection Circuitry of the MA352 has activated, the Vacuum Tubes LEDs are illuminated continuously with the color orange and the sound will be muted.
5. When the Power Transformer has overheated due to improper ventilation and/or high ambient operating temperature, AC Power is removed from the MA352. Normal operation will resume when the operating temperature is in a safe range again.
6. The MA352 Remote Control is capable of operating other components. For additional information go to www.mcintoshlabs.com.
7. The IR Input, with a 3.5mm mini phone jack, is configured for non-McIntosh IR sensors such as a Xantech Model HL85BK Kit. Use a Connection Block such as a Xantech Model ZC21 when two or more IR sensors need to be connected to the MA352. The signal from a connected External IR Sensor will have priority over the signal from the Front Panel IR Sensor.

8. When discarding the unit, comply with local rules or regulations. Batteries should never be thrown away or incinerated but disposed of in accordance with the local regulations concerning battery disposal. 
9. For additional information on the MA352 and other McIntosh Products please visit the McIntosh Website at www.mcintoshlabs.com.

Connector and Cable Information

XLR Connectors

Below is the Pin configuration for the XLR Balanced Input Connectors on the MA352. Refer to the diagram for connection:

- PIN 1: Shield/Ground
- PIN 2: + Output
- PIN 3: - Output

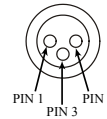

Power Control Connector

The Power Control Output Jack sends Power On/Off Signals (+12 volt/0 volt) when another McIntosh Component is connected. A 3.5mm stereo mini phone plug is used for connection to the Power Control Output.

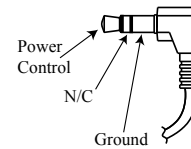

Data Port Connector

The Data Out Ports send Remote Control Signals to Source Components. A 3.5mm stereo mini phone plug is used for connection.

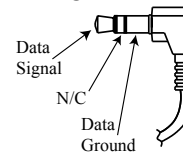

RS232 Data Port Cable

The RS232 Data Cable is a 3.5mm stereo mini phone plug for use with a compatible control system.

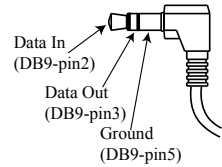

Output Terminal Connector

When cables with spade lugs are used for Loudspeaker Connection, the spade lugs need an opening of at least 3/10 inch (7.6mm).

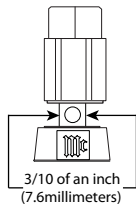

Introduction

Now you can take advantage of traditional McIntosh standards of excellence in the MA352 Integrated Amplifier. The Power Amplifier Solid State section of the MA352, with a power output of 200 watts per channel at 8 ohms, will drive a pair of quality Loudspeakers to a high level of performance.

The flexible Tube Preamplifier section provides connections for various analog input sources.

The MA352 reproduction is sonically transparent and absolutely accurate. The McIntosh Sound is “The Sound of the Music Itself.”

Performance Features

• Power Output

The MA352 consists of 200 watts (8 ohm) or 320 watts (4 ohm) per channel Stereo Power Amplifier with less than 0.03% distortion. The McIntosh MA352 is designed for connection of a single 8 ohm or 4 ohm Loudspeaker per channel. The Power Amplifier uses ThermalTrak¹ Output Transistors for lower distortion and cool operation.

• Power Guard

The patented McIntosh Power Guard circuit prevents amplifier clipping and protects your valuable Loudspeakers.

• Sentry Monitor and Thermal Protection

McIntosh Sentry Monitor power output stage protection circuits ensure the MA352 will have a long and trouble free operating life. Built-in Thermal Protection Circuits guard against overheating.

• Electronic Input and Output Switching

The Preamplifier uses Logic Controlled Electromagnetic Switches on all low level inputs and outputs. The operating functions are for reliable, noiseless, distortion free switching.

• Moving Magnet Phono Inputs

The MA352 Moving Magnet Input Circuitry uses the latest design to provide the lowest possible noise, distortion and flat frequency response.

• Equalizer Controls

The five Front Panel Equalizer Controls provide 12dB of boost or cut at their center frequencies. The MA352 remembers the Equalizer Circuitry Setting (On or Off) for each input.

• Multifunction Display

The Front Panel Display indicates source selection, volume levels and setup functions.

• Power Control Output

A Power Control connection for convenient Turn-On of a McIntosh Component.

• Remote Control

The Data Port together with the supplied Remote Control provide control of McIntosh Source Components connected to the MA352.

• Special Power Supply

The large Power Transformer, multiple filter capacitors with 60 Joules of Energy Storage and regulated Power Supply ensure stable noise free operation even though the power line varies.

• McIntosh Custom Binding Posts

McIntosh Patented gold plated output terminals deliver high current output. They accept large diameter wire and spade lugs. Banana plugs may also be used only in the United States and Canada.

• Super Mirror Finish Chassis with Glass Panel

The famous McIntosh Stainless Steel Chassis with Super Mirror Finish ensures the pristine beauty of the MA352 will be retained for many years. The famous McIntosh Illuminated Glass Panel uses long life Light Emitting Diodes (LEDs).

¹ ThermalTrak™ and ON Semiconductor are trademarks of Semiconductor Components Industries, LLC

Dimensions

The following dimensions can assist in determining the best location for your MA352. There is additional information on the next page pertaining to installing the MA352 into cabinets.

Front View of the MA352

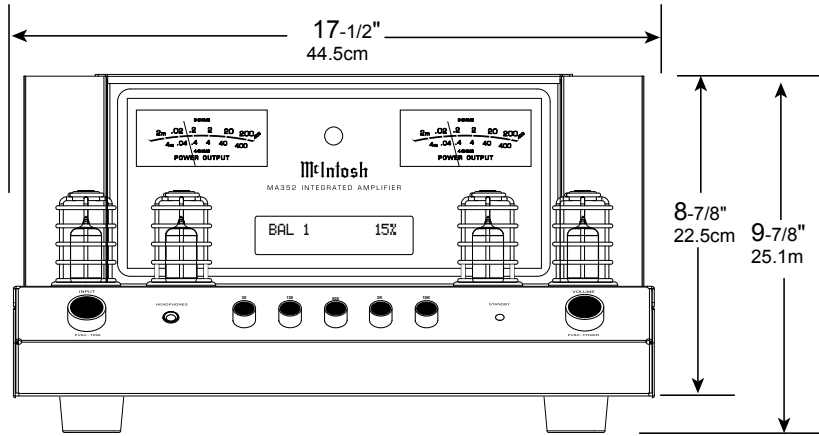

Right Side View of the MA352

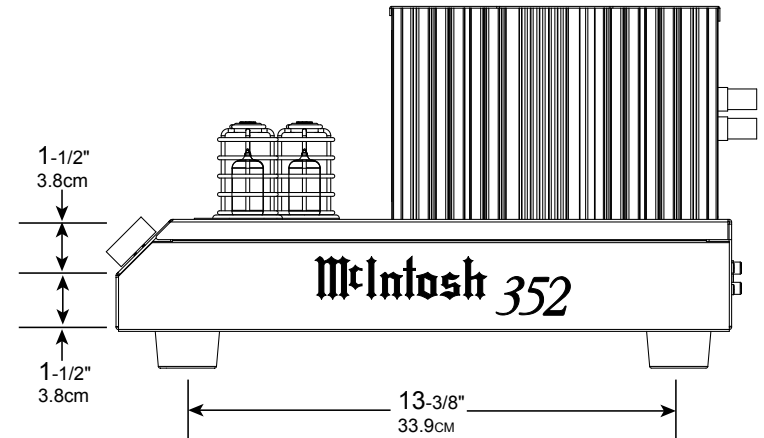

Rear View of the MA352

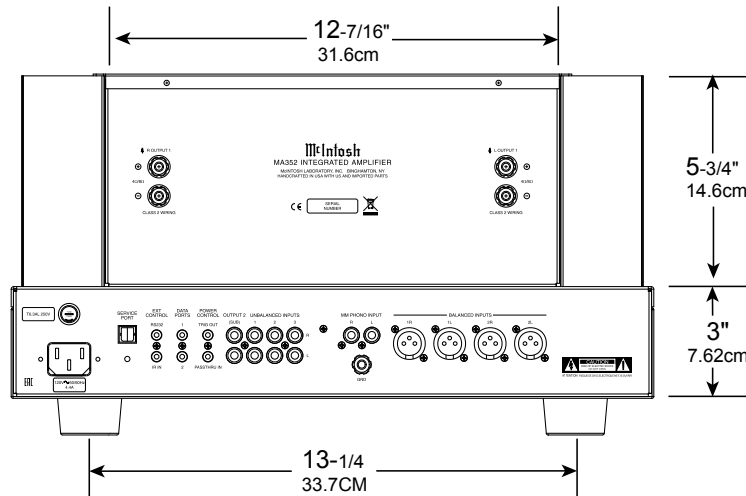

Top View of the MA352

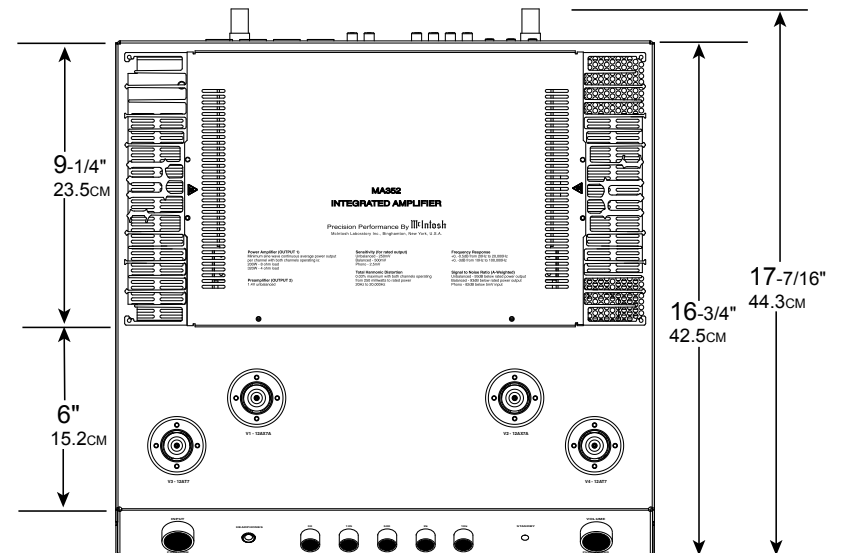

Installation

The MA352 Integrated Amplifier is designed to be placed upright on a table or shelf, standing on its feet. The required ventilation requirements are shown. Always provide adequate ventilation for your MA352. Cool operation ensures the longest possible operating life for any electronic instrument. Do not install the MA352 directly above a heat generating device, such as a Power Amplifier. Allow at least 6 inches (15.3cm) above the top, 5/8 inch (1.6cm) below the bottom and 2 inches (5.1cm) on each side of the Amplifier, so that airflow is not obstructed. Allow 22 inches (55.9cm) of depth for airflow and cable connections.

MA352 Front View

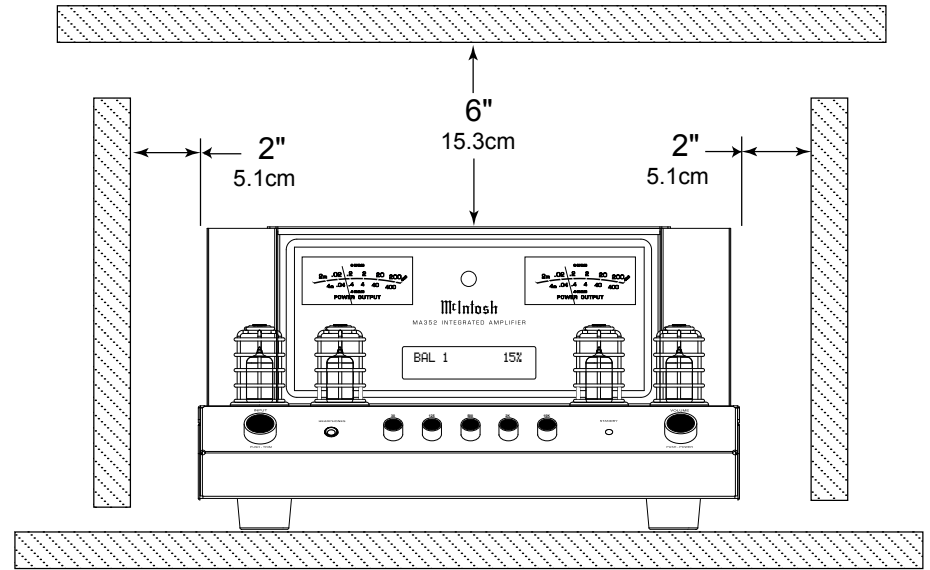

MA352 Side View

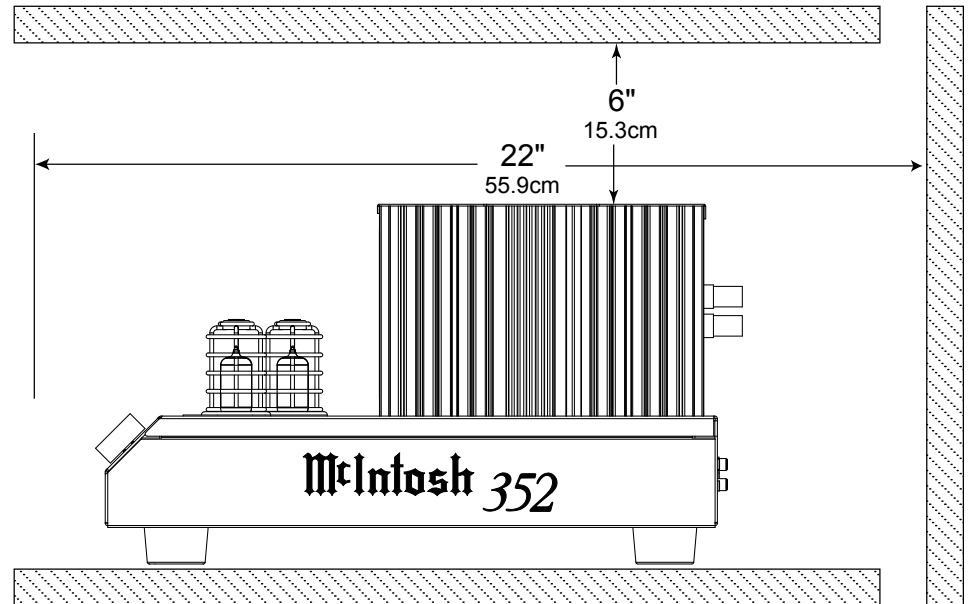



Right OUTPUT connections for a 4 or 8 ohm Loudspeaker

POWER CONTROL TRIG OUTPUT sends turn On/Off signals to a McIntosh Component when the MA352 is switched On/Off

OUTPUT 2 SUB unbalanced send signals to Power Amplifier(s) and is switched On/Off with the Remote Control Push-Button

Left OUTPUT connections for a 4 or 8 ohm Loudspeaker

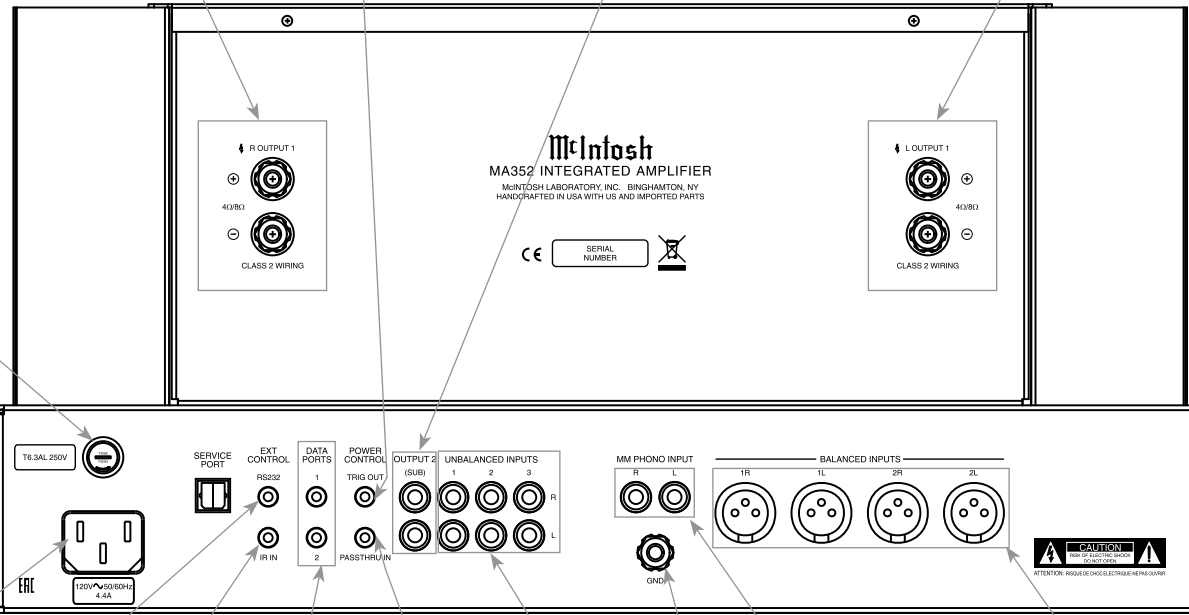

Main Fuse holder, refer to information on the back panel of your MA352 to determine the correct fuse size and rating

Connect the MA352 power cord to a live AC outlet. Refer to information on the back panel of your MA352 to determine the correct voltage for your unit

RS232 connector for connection to a compatible control system

IR Input for signals from a compatible IR Room Sensor

DATA PORTS are assignable to send signals to Source Components to allow control with the MA352 Remote Control

PASSTHRU Input Power Control Input receives turn On/Off signals from an Audio/Video Control Center

GND terminal accepts a ground wire from a turntable

BALANCED INPUTS 1 and 2 accept high level program source signals

Connecting Components

The MA352 has the ability to automatically switch power On/Off to McIntosh Source Components via the Power Control connections. The Data Port Connections allow for the remote operation of basic functions using the MA352 Remote Control.

The connection instructions below, together with the MA352 Input and Output Connection Diagrams located on the separate folded sheets “Mc2A/2B” and “Mc3A”, are examples of typical audio systems. Your system may vary from this, however the actual components would be connected in a similar manner. For additional information refer to “Connector and Cable Information” on page 6.

Power Control Connections:

1. Connect a Control Cable from the MA352 POWER CONTROL OUTPUT Jack to the Power Control In on the Turntable.
2. Connect a Control Cable from the Turntable Power Control Out Jack to the Media Bridge Power Control In Jack.
3. Connect a Control Cable from the Media Bridge Power Control Out Jack to the AM/FM Tuner Power Control In Jack.
4. Connect a Control Cable from the AM/FM Tuner Power Control Out Jack to the SACD/CD Player Power Control In Jack.
5. Optionally, connect the SACD/CD Player Power Control out Jack to the Secondary Power Amplifier PWR CTRL.
6. Optionally, connect the A/V Processor Zone A Power Control to the MA352 PASSTHRU POWER CONTROL input Jack.
7. Connect any additional McIntosh Components in a similar manner, as outlined in steps 1 thru 3.

Data Control Connections:

8. Connect a Control Cable from the MA352 DATA PORTS 1 Jack to the SACD/CD Player Data In Jack.
9. Connect a Control Cable from the MA352 DATA PORTS 2 Jack to the AM/FM Tuner Data In Jack.

Audio Connections:

10. Connect XLR Balanced Cables from the MA352 BALANCED INPUT 1 Connectors to the Media Bridge Audio Output Balanced Connectors.
11. Connect the Audio Cables from the AM/FM Tuner UNBAL Connectors to the MA352 UNBALANCED 1 Connectors.
12. Connect the Audio Cables from the SACD/CD Player UNBAL Connectors to the MA352 UNBALANCED 2 Connectors.
13. Connect the Audio Cables from the Turntable PHONO OUT Jacks to the MA352 MM PHONO Connectors.
14. Connect any additional Components in a similar manner, as outlined in steps 7 thru 12.
15. Optionally, connect the A/V Processor Left Front and Right Front XLR Connectors to the MA352 2L and 2R Balanced XLR Connectors.

Ground Connections:

16. Connect the Ground Cable coming from the Turntable to the MA352 GND Binding Post.

Output Terminals

When connecting the Loudspeaker Hookup Cables to the MA352 Amplifier Output Terminals please follow the steps below:

1. Rotate the top of the Output Terminal Post counterclockwise until an opening appears. Refer to figures A and B.

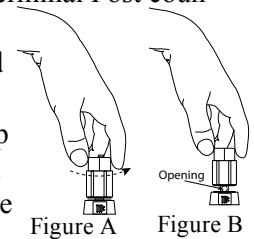

2. Insert the Loudspeaker hookup cable into the Output Terminal Post opening or the cable spade lug around the center post of the Output Terminal. Refer to figure C.

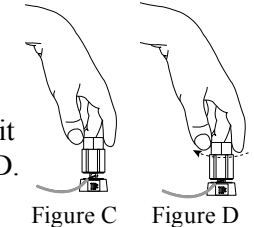

3. Rotate the top of the Output Terminal Post clockwise until it is finger tight. Refer to figure D.
4. Place the supplied McIntosh Wrench over the top of the Output Terminal and rotate it one quarter of a turn (90°) to secure the Loudspeaker Cable Connection. **Do not over tighten.** Refer to figure E.

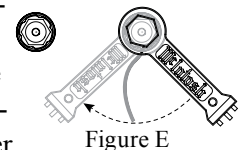

How to Connect Loudspeakers

Caution: Do not connect the AC Power Cord to the MA352 Rear Panel until after the Loudspeaker Connections are made. Failure to observe this could result in Electric Shock.

The MA352 Connection Instructions, located on the next page together with the Separate Diagram Sheets, are for a typical audio system. Your system may vary from this, however the actual components would be connected in a similar manner. For additional information refer to “Connector and Cable Information” on page 6.

Caution: Do not connect the AC Power Cord to the MA352 Rear Panel until after the Loudspeaker Connections are made. Failure to observe this could result in Electric Shock.

The McIntosh MA352 Power Amplifier Circuitry is designed for Loudspeakers with an impedance of 8 Ohms or 4 Ohms. Connect a single Loudspeaker only to the Right and Left Output Terminals.

When connecting Loudspeakers to the MA352 it is very important to use cables of adequate size, so there is little to no power loss in the cables. The size is specified in Gauge Numbers or AWG (American Wire Gauge). The smaller the Gauge number, the larger the wire size:

Loudspeaker Cable Distance vs Wire Gauge Guide			
Loudspeaker Impedance	25 feet (7.62 meters) or less	50 feet (15.24 meters) or less	100 feet (30.48 meters) or less
4 Ohms	14AWG	12AWG	10AWG
8 Ohms	16AWG	14AWG	12AWG

1. Prepare the Loudspeaker Hookup Cable for attachment to the MA352 Power Amplifier:

Bare wire cable ends:

Carefully remove sufficient insulation from the cable ends, refer to figures F, G & H. If the cable is stranded, carefully twist the strands together as tightly as possible.

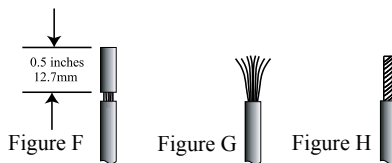

- Notes:
1. If desired, the twisted ends can be tinned with solder to keep the strands together.
 2. The prepared bare wire cable ends may be inserted into spade lug connectors.
 3. Banana plugs are for use in the United States and Canada only.

Banana Plugs are for use in the United States and Canada only:

2. Attach the previously prepared bare wire cable ends into the banana plugs and secure the connections. Refer to figure I.

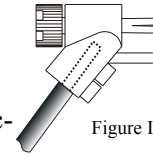

3. Rotate the Output Terminal Post clockwise until it is finger tight. Refer to figure J. Then using the McIntosh Wrench, rotate the top of the Output Terminal one quarter of a turn (90°). **Do not over tighten.**

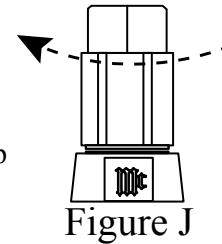

4. Referring to figure K, connect the Loudspeaker hookup cables with banana plugs into the hole at the top of the terminal to the MA352 Negative Output Terminal and Positive Output Terminal to the Loudspeaker Terminal Connections being careful to observe the correct polarities.

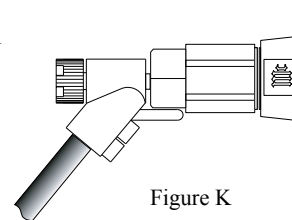

Note: The illustration located on the separate folded sheet "Mc2B" is for connection to an 8Ω (ohms) Loudspeaker.

If the Loudspeaker's impedance is in-between the available connections, use the nearest lower impedance connection. Refer to "General Information" Note 6 on page 6 for additional information.

WARNING: Loudspeaker terminals are hazardous live and present a risk of electric shock. For additional instruction on making Loudspeaker Connections contact your McIntosh Dealer or McIntosh Technical Support.

5. Connect the MA352 power cord to an active AC outlet.

Spade Lug or Wire Connections:

6. Connect the Loudspeaker hookup cables to the MA352 Negative Output Terminal and Positive Output Terminal to the Loudspeaker Terminal Connections being careful to observe the correct polarities. Insert the spade lug connector or prepared section of the cable end into the terminal side access hole, and tighten the terminal cap until the cable is firmly clamped into the terminals so the lugs or wire cannot slip out. Refer to figures L and M.

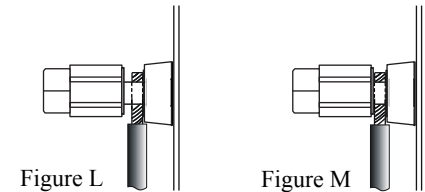

Note: The illustration located on the separate folded sheet "Mc2B" is for connection to an 8Ω (ohms) Loudspeaker.

Refer to "General Information" Note 6 on page 6 for additional information.

WARNING: Loudspeaker terminals are hazardous live and present a risk of electric shock. For additional instruction on making Loudspeaker Connections contact your McIntosh Dealer or McIntosh Technical Support.

7. Connect the MA352 power cord to an active AC outlet.

MA352 Switch Power On

Press the Volume Control on the MA352 or press the  (Power ON) Push-button on the Remote Control to switch On the MA352. The MA352 will go through a TUBE WARMUP cycle (15 seconds), with the Audio Muted. The Tubes in the MA352 glow an orange color and a brief startup initialization with the Front Panel Information Display indicating “MA352, TUBE WARMUP”. Refer to figure B.

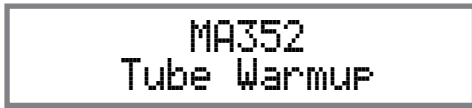

Figure B

When the tube warm up procedure has completed. The illumination of the Tubes will now glow a green color; this is followed by the last Input Source listened to and the volume setting indication starting at zero and then increasing to the last used volume setting. Refer to figure C.



Figure C

Preamplifier Small Signal Vacuum Tube

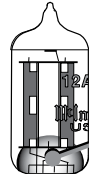

LED Illumination Color:
Orange- Warmup Mode and Power Guard
Green - Normal Operation

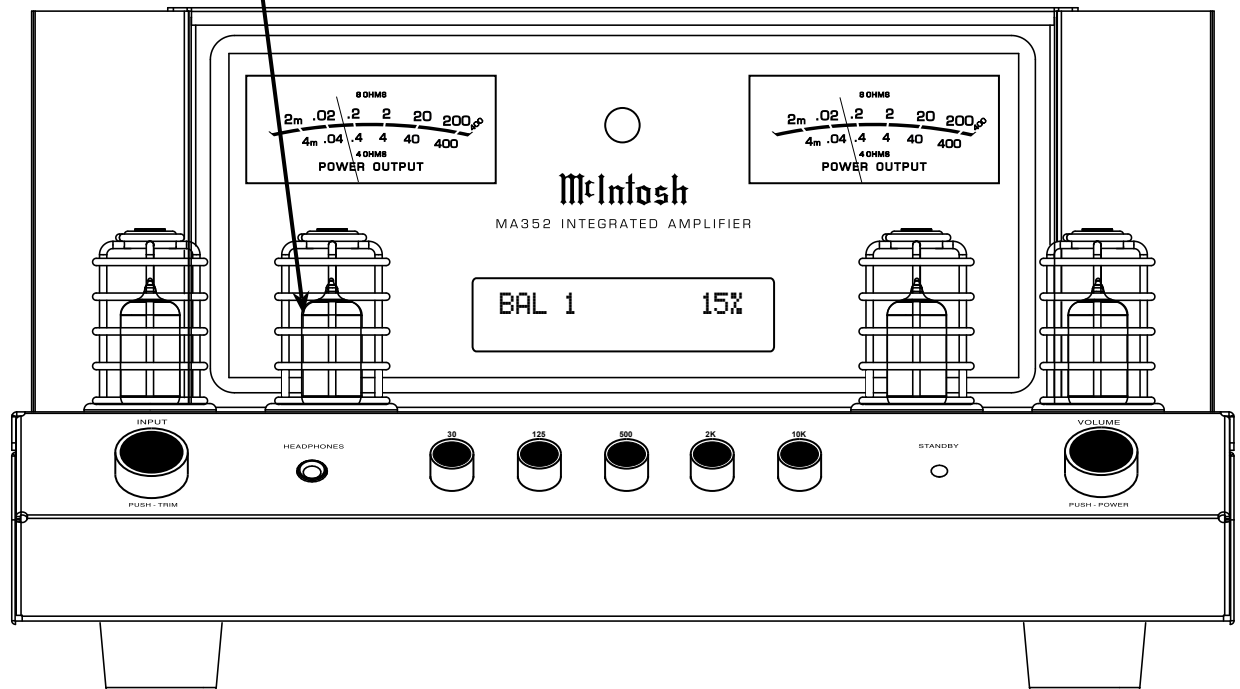

Figure A



LEDs illuminate during the time a remote command is sent and when programming the remote control

Select the DEVICE to issue a remote control command to

SETUP Push-button is used as a "Shift Key" to select a function with blue color nomenclature

Selects AM Tuner Operating Functions, select Output 1 when used with the SETUP/shift Push-button and Track Selection on certain McIntosh CD Players

Press the Trim Push-button and then the LEVEL UP Push-button to select and adjust various functions. MENU is used with McIntosh Models displaying choices on a video screen

Activates the TRIM Mode. GUIDE is used with McIntosh Models displaying instructions on a video screen

Press the Trim Push-button and then the LEVEL DOWN Push-button to select and adjust various functions. INFO is used with McIntosh Models displaying information on a video screen

Scrolls through the available INPUTS

Mutes the audio

Selects transport functions of STOP, PLAY/PAUSE, RECORD, BACK for the previous-selection, FAST-REVERSE, FAST-FORWARD and NEXT for the next selection

Selects Previous Tuner Station PRESET

Tuner scans Down the dial to SEEK the next Station

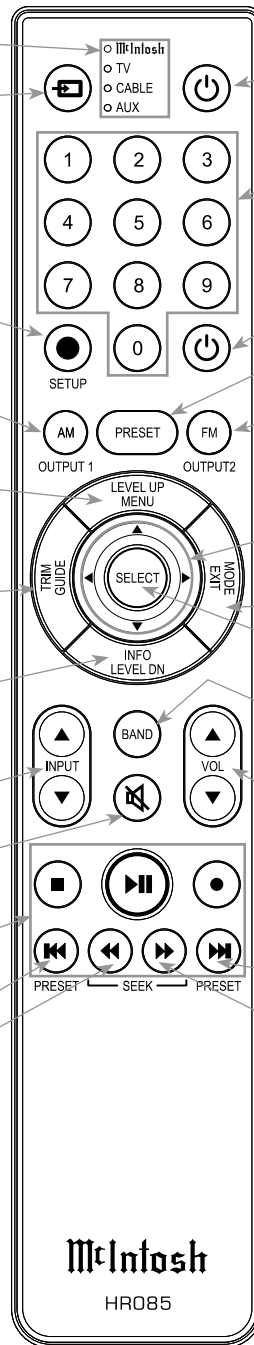

Press to Power the Preamplifier ON

Use to select tuner presets, direct access an AM/FM Station Frequency, disc tracks or any numbered operation

Press to Power the Preamplifier OFF

Direct access to stored Tuner PRESETS when used with the numeric Push-buttons (0 thru 9)

Selects FM Tuner Operating Functions, select Output 2 when used with the SETUP/shift Push-button and Track Selection on certain McIntosh CD Players

Use ▲ and ▼ to tune Up or Down the AM/FM Dial, use ► and ◀ for the next or previous HD Radio Program (where applicable)

EXIT the TRIM Menu and is used with McIntosh Models displaying information or choices on a video screen

Used to SELECT/Enter the indicated choice

Press to change broadcast BANDs on a connected Tuner. Select certain functions on a variety of McIntosh Models

Adjusts the VOLume level up or down

Selects Next Tuner Station PRESET

Tuner scans Up the dial to SEEK the next Station

Note: Push-buttons whose function is not identified above are for use with other McIntosh Products.

How to use the Remote Control

The supplied MA352 Remote Control (HR085) is capable of directly controlling the functions of contemporary McIntosh Source Components connected to the MA352 via the Data Ports.

- Notes: 1. If at any time the MA352 seems unresponsive to the HR085 Remote Control Commands, press the  DEVICE Push-button to select McIntosh first.*
- 2. For additional information on using the HR085 Remote Control with the McIntosh Model, please refer to the "How to Operate" starting on page 22.*
- 3. For additional information on assigning the Data Ports, refer to "How to Setup" on page 17.*

Trim

Press the TRIM Push-button until the desired Trim function (Balance, Trim Level, etc.) appears on the MA352 Front Panel Display, then press the LEVEL Up or Down Push-button to adjust the Trim setting.

Note: Press the TRIM Push-button to recall the last Trim function selected. For additional information on using the Trim Functions refer to "How to Operate" pages 22-25.



Preamplifier Small Signal Vacuum Tube

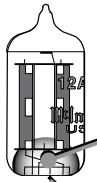

LED Illumination Color:
Orange- Warmup Mode and
-Power Guard Activates
Green - Normal Operation

INFORMATION DISPLAY indicates the Sources, Volume, Trim Operational Functions and Setup Mode Settings

Meter indicates the Left Channel Output of the amplifier

IR Sensor receives commands from a Remote Control

Meter indicates the Right Channel Output of the amplifier

Preamplifier Small Signal Vacuum Tube

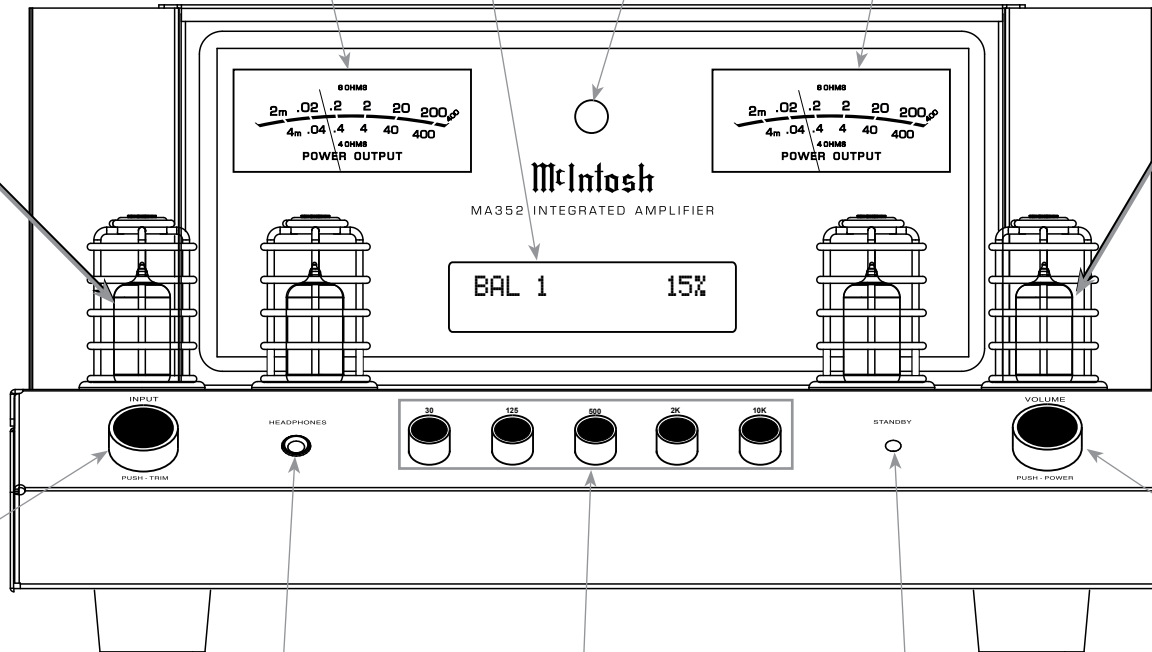

INPUT Control used to select a source for listening and recording. The control is also used to enter the TRIM or SETUP Modes and select the various functions

Connection for low impedance dynamic HEADPHONES, for private listening

EQUALIZER Controls increase or decrease the volume levels at the Center Frequencies of 30Hz, 125Hz, 500Hz, 2,000Hz, and 10,000Hz

STANDBY LED Indicator

VOLUME Control allows adjustment of the listening level for both channels. Switches the MA352 ON or OFF (Standby). Also used to change the various TRIM and SETUP Functions and Resets the microprocessors

How to Operate the Setup Mode

Your McIntosh MA352 has been factory configured to allow immediate enjoyment of superb audio without the need for further adjustments. If you wish to make changes to the factory default settings, a Setup Feature is provided to customize the operating settings using the Front Panel Information Display. Refer to the MA352 Front Panel Illustration on the previous page while performing the following steps.

Note: If the MA352 is currently On, proceed to step 2.

1. Press the Volume Control on the MA352 or press the  (Power ON) Push-button on the Remote Control to switch On the MA352. Refer to page 9 for information about Switching Power On to the MA352. After the MA352 goes through its start-up, the Front Panel Information Display indicates the last used source and volume setting. This is followed by the volume setting indication starting at zero and then increasing to the last used volume setting. Refer to figure 1.



Figure 1

2. Press and hold in the INPUT Control until the Front Panel Information Display indicates “MA352 V1.00, (or higher Firmware version) - S/N: AHN_____” (Serial Number). Refer to figure 2.



Figure 2

3. Rotate the INPUT Control to select the Setup Mode Menu item, “SETUP: Inputs, (Hold INPUT)”. Refer to figure 3.



Figure 3

Continue to rotate the INPUT CONTROL to view the other SETUP Mode Options.

4. To exit from the SETUP Mode, press and hold in the INPUT Control and the Front Panel Display will indicate its normal display. Refer to figure 1.

Default Settings

The Default Settings Chart below indicates the Function Name, Default Setting and the Page Number for additional information.

Default Settings		
Function Name	Setting	Page No.
MA352	V1.00	13
INPUTS	On/Off / Rename	13-15
OUTPUT 2	Stereo / Mono	15
PASSTHRU	Various Inputs	16
DATA PORTS (1 and 2)	All Data and Various Inputs	16
RS232	Comm Port Baud Rate	17
IR Codes	Normal	
Front IR Sensor	Enabled	19
Auto- Off	Enabled	19
Factory Reset	Default Settings	20

Firmware Version

The MA352 functionality is controlled by internal software that is known as Firmware. The Version of the Firmware in the MA352 can be identified at any time by utilizing the Setup Mode.

1. Press and hold in the INPUT Control to enter Setup Mode.
2. Referring to the Front Panel Information Display—the number after the character “V” is the Firmware number. Refer to figure 2.

3. To exit the Setup Mode, press the INPUT Control.

Input Settings

The MA352 provides the ability to switch unused INPUTS Off (or back On if they have been previously switched Off). The default INPUT Names can be changed to match the name of the component connected to it or any other custom name desired (within 10 Characters).

INPUT SWITCHED ON/OFF:

In the following example, the UNBAL 3 Input will be switched Off.

Note: When an INPUT is switched Off, its name will no longer appear on the Front Panel Information Display when using the INPUT Control (Front Panel or Remote Control).

1. Press and hold in the INPUT Control to enter the SETUP MODE. Refer to figure 3.
2. Rotate the INPUT Control until “SETUP: Inputs, (Hold INPUT)” appears on the Information Display. Refer to figure 3.
3. Press and hold in the INPUT Control until “SETUP: UNBAL 3, On / Name (Hold IN)” appears on the Display. If necessary rotate the INPUT Control to select the UNBAL 3 Input. Refer to figure 4.



Figure 4

4. To switch the UNBAL 3 Input Off, rotate the VOLUME Control until the display indicates “SETUP: UNBAL 3, Off”. Refer to figure 5.



Figure 5



Input Settings, con't

- Exit the SETUP Mode by several presses of the INPUT Control.

RENAME INPUT:

In the following example, the BALANCED 1 (BAL 1) Input will be renamed to match up with the component connected (refer to page 11, step 9).

The MA352 Default Input Names (UNBAL 1, BAL 1, COAX 1, etc.) as indicated on the Front Panel Display can be customized to a different name up to ten characters long (TUNER, CD PLAYER, etc.). The available characters for renaming the input include the following: ! < > * , / - _ 0 1 2 3 4 5 6 7 8 9 A B C D E F G H I J K L M N O P Q R S T U V W X Y Z.

In the following example, the BAL 1 Input will be renamed to "MEDIA BRDG".

- Press and hold in the INPUT Control to enter the SETUP MODE. Refer to figure 3, on page 17.
- Rotate the INPUT Control until "SETUP: Inputs, (Hold INPUT)" appears on the Information Display. Refer to figure 6.



Figure 6

- Press and hold in the INPUT Control until "SETUP: BAL 1, On/Name (Hold INPUT)" appears on the Display. If necessary rotate the INPUT Control to select the BAL 1 Input. Refer to figure 7.



Figure 7

- Press and hold in the INPUT Control until "RENAME: BAL" appears on the Display. The character "B" is flashing to indicate it is ready to be changed. Refer to figure 8.



Figure 8

- Rotate the VOLUME (ADJUST) Control to change the character "B" to "M". Refer to figure 9.



Figure 9

- Rotate the INPUT Control until the character "A" is flashing, then rotate the VOLUME (ADJUST) Control to change the character "A" to "E". Refer to figure 10.



Figure 10

- Rotate the INPUT Control until the character "L" is flashing, then rotate the VOLUME (ADJUST) Control to change the character "L" to "D". Refer to figure 11.



Figure 11

- Rotate the INPUT Control until the "_" empty space to the right of character D is flashing, then rotate the VOLUME (ADJUST) Control to change the "_" empty space to character to "I". Refer to figures 12 and 13.



Figure 12



Figure 13

- Repeat steps 8 thru 13 until the new name of "RENAME: BAL 1, MEDIA BRDG" is indicated on the Front Panel Display. Refer to figures 14 thru 17.



Figure 14



Figure 15



Figure 16



Figure 17

- To save the new name, press and hold in the INPUT Control until "SETUP: MEDIA BRDG, ON / Rename" appears on the Front Panel Information Display. Refer to figure 18.



Figure 18

- Exit the SETUP Mode by several presses of the INPUT Control.

Note: For convenience, an "Input Assignment Chart" on a separate sheet "Mc5A/5B" has been provided to keep track of changes.

OUTPUT 2

The OUTPUT 2 Rear Panel Unbalanced Connectors are adjustable for their mode of operation:

1. Press and hold in the INPUT Control to enter the SETUP MODE. Refer to figure 3 on page 17.
2. Rotate the INPUT Control until “SETUP: Output 2, Stereo” appears on the Information Display. Refer to figure 19.



Figure 19

3. Rotate the VOLUME (ADJUST) Control to change from the “Stereo” mode setting to the “Mono” mode of operation. Refer to figure 20.

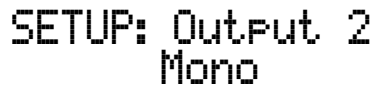

Figure 20

Passthru

When the MA352 is part of a Home Theater or Multichannel Audio System, the Connections from the Audio/Video Processor or Surround Decoder can switch On the MA352 and provide two audio channels, refer to page 11. The Setup Mode allows selection of the specified MA352 Input to be used for the Right and Left Front Channels. In the example below, the Right and Left Front Channels from the Audio/Video Processor will be connected to the BALANCED 2 Input Connectors on the MA352. Refer to pages 11 and 12 for additional connection information.

Note: The Phono Input is not assignable as a Passthru Input.

1. Press and hold in the INPUT Control to enter the SETUP MODE. Refer to figure 3 on page 17.

2. Rotate the INPUT Control until “SETUP: Passthru, OFF” appears on the Information Display. Refer to figure 21.



Figure 21

3. Rotate the VOLUME (ADJUST) Control to select “BAL 2” Input. Refer to figure 22.



Figure 22

4. Exit the SETUP Mode by several presses of the INPUT Control.

Data Port

Data Port Connection between the MA352 and a McIntosh Source Component allows for basic function control of the source component using the MA352 Remote Control. By default, the Data Port setting of “All Data” sends the received IR Data to the DATA PORT Output Jack. To dedicate the Data Port for only one MA352 source component perform the following Steps:

1. Press and hold in the INPUT Control to enter the SETUP MODE. Refer to figure 3 on page 17.
2. Rotate the INPUT Control until “SETUP: Data Ports, (Hold INPUT)” appears on the Information Display. Refer to figure 23.



Figure 23

3. Press and hold in the INPUT Control and the following display will appear “SETUP: Data Port 1, All Data”. Refer to figure 24.



Figure 24

4. Rotate the VOLUME (ADJUST) Control to select the BAL 1 Input for Data Port 1. Refer Figure 25 “SETUP: Data Port 1, BAL 1”.



Figure 25

5. The MA352 has a second Data Port that another Source Input can be connected for remote control.
6. Press and hold in the INPUT Control to enter the SETUP MODE. Refer to figure 3 on page 17.
7. Rotate the INPUT Control until “SETUP: Data Ports, (Hold INPUT)” appears on the Information Display. Refer to figure 23.
8. Press and hold in the INPUT Control and the following display will appear “SETUP: Data Port 1, All Data”. Refer to figure 24.
9. Rotate the INPUT Control until the Front Panel Display now indicates “SETUP: Data Port 2, All Data”. Refer to figure 26.



Figure 26

10. Rotate the VOLUME (ADJUST) Control to select the UNBAL 2 Input for Data Port 2. Refer Figure 27 “SETUP: Data Port 2, UNBAL 2”.



Figure 27

11. Exit the SETUP Mode by several presses of the INPUT Control.



Comm Port Baud Rate

The MA352 may be remotely controlled from a compatible control system connected to the Rear Panel RS232 Jack. The speed at which the MA352 communicates (8 bit, no parity and 1 stop bit) with other equipment is adjustable from 9,600 bits per second to 115,200 bits per second. To change from the default speed of 115,200 bits per second, perform the following steps:

1. Press and hold in the INPUT Control to enter the SETUP MODE. Refer to figure 3 on page 17.
2. Rotate the INPUT Control until “SETUP: RS232, 115200 Baud” appears on the Information Display.



Figure 28

Refer to figure 28.

3. Rotate the VOLUME (ADJUST) Control to select the desired Baud Rate Speed.
4. Exit the SETUP Mode by several presses of the INPUT Control.

Remote Control Codes

The Remote Control included with the MA352 utilizes the NORMAL McIntosh Control Codes. The Second Set of Control Codes the MA352 will respond to is referred to as the ALTERNATE Codes. The Alternate Codes are used when the MA352 is used in the same location as another McIntosh Preamplifier and/or A/V Processor. This will prevent the Remote Control from affecting the operation of both units at the same time. To activate the Remote Control ALTERNATE Codes perform the following steps:

1. Press and hold in the INPUT Control to enter the SETUP MODE. Refer to figure 3 on page 17.
2. Rotate the INPUT Control until “SETUP: IR Codes, Normal” appears on the Information Display. Refer to figure 29.



Figure 29

3. Rotate the VOLUME (ADJUST) Control to the Alternate Codes. Refer to figure 30.



Figure 30

4. It is now necessary to change the HR085 Remote Control over to the Alternate Codes. Information on the HR085 Remote Control is available for download from the McIntosh Web Site:

<http://www.mcintoshlabs.com/us/Products/pages/ProductDetails.aspx?CatId=preamplifiers&ProductId=MA352>

5. Exit the SETUP Mode by several presses of the INPUT Control.

IR Sensor

The MA352 Front Panel Sensor, which receives the signals from the HR085 Remote Control, can be switched off to prevent interference when an external IR Sensor is connected. To de-activate the Front Panel IR Sensor perform the following steps:

1. Press and hold in the INPUT Control to enter the SETUP MODE. Refer to figure 3 on page 17.
2. Rotate the INPUT Control until “SETUP: Front IR, Enabled” appears on the Information Display. Refer to figure 31.



Figure 31

3. Rotate the VOLUME (ADJUST) Control to select “Disabled”. Refer to figure 32.

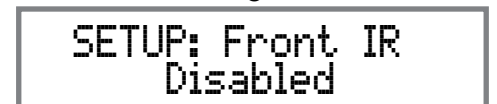

Figure 32

4. Exit the SETUP Mode by several presses of the INPUT Control.

Power Mode

The MA352 incorporates an Auto Off Feature, which automatically places the preamplifier into the Power Saving Standby/Off Mode. This occurs approximately 30 minutes after there has been an absence of user activity (includes changes to any of the Operation Functions such as source selection, volume adjustment, etc.) or absence of an audio signal. If it is desirable to disable the Auto Off Feature perform the following steps:

1. Press and hold in the INPUT Control to enter the SETUP MODE. Refer to figure 3 on page 17.
2. Rotate the INPUT Control until "SETUP: Auto Off, Enabled" appears on the Information Display. Refer to figure 33.



SETUP: Auto-Off
Enabled

Figure 33

3. Rotate the VOLUME (ADJUST) Control to select Disabled. Refer to figure 34.



SETUP: Auto-Off
Disabled

Figure 34

4. Press the INPUT Control to exit the Setup Mode.

Factory Reset

If it becomes desirable to reset all the adjustable settings (Setup and Trim Settings) to the factory default values, perform the following steps:

1. Press and hold in the INPUT Control to enter the SETUP MODE. Refer to figure 3 on page 17.
2. Rotate the INPUT Control until "FACTORY RESET, (Hold INPUT)" appears on the Information Display. Refer to figure 35.



FACTORY RESET
(Hold INPUT)

Figure 35

3. Press and hold in the INPUT Control until "FACTORY RESET, In Progress!" appears on the Information Display, then release the INPUT Control. Refer to figures 36 and 37.



FACTORY RESET
In Progress

Figure 36



FACTORY RESET
Completed!

Figure 37

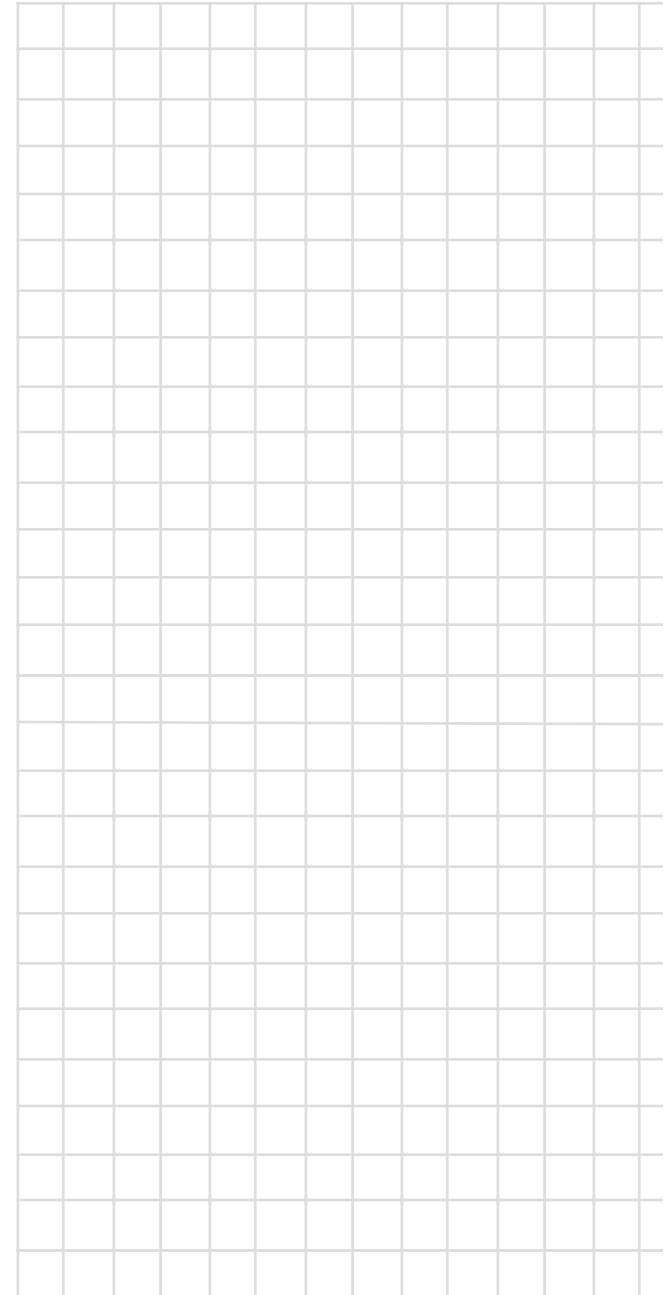

4. Press the Front Panel STAND/BY Push-button to switch On the MA352.





How to Operate the MA352

Power On and Off

The Red LED to the left of the VOLUME Control lights to indicate the MA352 is in Standby mode. To switch ON the MA352, Press the VOLUME Control on the Front Panel or press the  Push-button on the Remote Control. Refer to page 13 for information about Switching Power On to the MA352. This is followed by the Front Panel Display indicating the last used source and the volume setting indication starting at zero and then increasing to the last used volume setting. Refer to figures 50, 51 and 52. To switch OFF the MA352, press the VOLUME Control on the Front Panel or press the  Power Push-button on the Remote Control.

Note: For an explanation of the Remote Control Push-button functions, refer to pages 14 and 15.

Source Selection

Rotate the INPUT Control to select the desired source

or push the INPUT Push-button on the Remote Control to select the Phono Input. Refer to figures 51 and 52.





Figure 51



Figure 52

Volume Control

Rotate the Front Panel VOLUME Control or use the  or  Push-buttons on the Remote Control for the desired listening level. Refer to figures 50 and 53.

Trim Functions

The MA352 has a variety of different Trim Selections

with Adjustments. The Trim Selections include Balance, Input Trim Level, Equalizer Mode, Mono/Stereo Mode, Amplifier Meter Lights, Display Brightness, and when Headphones are connected, HXD Mode. The Trim Settings are stored in memory independently for each Input Source Selected, except the Meter Illumination and Display Brightness settings of On or Off, which are the same for all inputs.

Note: Selection and Adjustment of all Trim Functions may be performed by pressing the Front Panel INPUT Trim Control and then rotating it to select the desired Trim Function. Then use the VOLUME Adjust Control to change the setting. Remote Control TRIM Push-Button together with the LEVEL UP / LEVEL DN Push-button may also be used. Refer to figure 53.

BALANCE

Listening balance varies with different program sources, room acoustics and listening positions relative to the Loudspeakers. Use the Balance (Trim Function) as needed to achieve approximately equal listening volume levels in each Loudspeaker. To adjust the Balance perform the following:

1. Press the TRIM Push-button repeatedly on the Remote Control until “L BALANCE R, ||” appears on the Front Panel Display. Refer to figure 54.

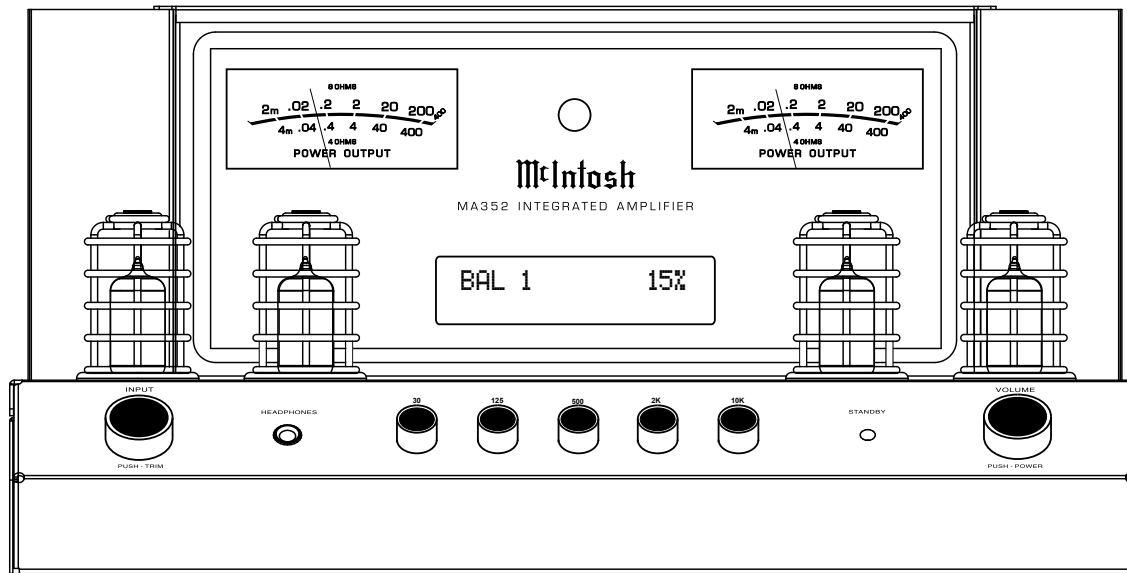

Figure 50

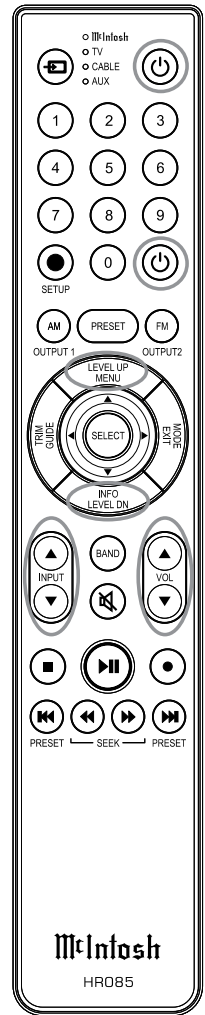

Figure 53



Figure 54

Note: The Front Panel INPUT Control may also be used.

2. Press the LEVEL UP / DOWN Push-buttons on the Remote Control to emphasize the Right Channel (refer to figure 55) or the Left Channel (refer to figure 56).



Figure 55



Figure 56

The Front Panel Display indicates the Balance changes are from 0 to 50 dB. After approximately 4 seconds the Information Display returns to indicate the Source Selection and Volume Level. To verify the Balance setting without changing it, use the TRIM Push-button and select Balance.

EQUALIZER MODE

Press the TRIM push-button or the INPUT Front Panel Control to select EQUALIZER function as it is indicated on the Front Panel Information Display. The built-in four band Frequency Equalizer provides more precise adjustment of sound than standard Bass and Treble Controls. By default, the Equalizer is Off for all Input Sources and the Equalizer Circuitry is bypassed. Any Input Source may be assigned to have the Equalizer On when selected. To activate the Equalizer for a given Input Source, select the desired Input Source, perform the following steps:

Note: The audio signal present at the FIXED OUT Jacks is unaffected by the Equalizer settings.

1. Select the desired Input Source.
2. Select “EQUALIZER, Off” as indicated on the Front Panel Information Display. Refer to figure 57.



Figure 57

3. Set the EQUALIZER On for the desired Input by using the Front Panel Volume Control or the Remote Control Push-buttons. Refer to figure 58.



Figure 58

Refer to graph on page 26 for additional information on using the MA352 Equalizer. After approximately 5 seconds the Information Display returns to indicate the Source Selection and Volume Level.

MONO/STEREO MODE

Press the TRIM push-button or the INPUT Front Panel Control to select MODE function as it is indicated on the Front Panel Information Display. By default the Stereo Mode is active for all Input Sources however, any Input Source may be assigned to the Mono Mode of operation. To change Stereo Mode to Mono for a given Input Source, perform the same type of steps by using the Front Panel Controls or the Remote Control Pushbuttons as done for Treble and/or Bass Settings:

Note: The audio signal present at the FIXED OUT Jacks is affected by the Stereo/Mono setting.

1. Select the desired Input Source.
2. Select “MONO / STEREO, _____” as indicated on the Front Panel Information Display.

Refer to figure 59.



Figure 59

3. To select MONO Mode adjust the TRIM LEVEL. Refer to figure 60.



Figure 60

After approximately 6 seconds the Information Display returns to indicate the Source Selection and Volume Level.

OUTPUT 1 AND 2

Press the TRIM push-button or the INPUT Front Panel Control to select the OUTPUT 1 or OUTPUT 2 function as they are indicated on the Front Panel Information Display. The Output 1 setting is for loudspeakers connected to the Power Amplifier Circuitry of the MA352. The Output 2 Setting is for an external Power Amplifier connected to the MA352 Rear Panel Preamplifier Circuitry Output Jacks. Select the appropriate Setting for the Output 1 and Output 2 settings, either On or Off. Refer to figures 61, 62, 63 and 64 on this and the next page.



Figure 61

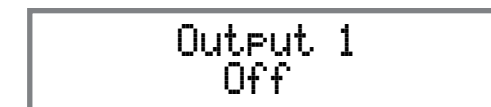

Figure 62



How to Operate the MA352, con't

Output 2
On

Figure 63

Output 2
Off

Figure 64

TRIM LEVEL

Source Components can have slightly different volume levels resulting in the need to readjust the MA352 Volume Control when switching between different sources. The MA352 allows the adjustment of levels for each of the Source Inputs for the same relative volume. To adjust the Trim Level for the currently selected Input Source perform the following steps:

1. Select "INPUT TRIM, 0.0dB" as indicated on the Front Panel Information Display. Refer to figure 65.

INPUT TRIM
0.0 dB

Figure 65

2. Adjust the Trim Level of each Input to match the average volume level of the Input most frequently listened to. The range of adjustment is ± 6.0 dB in half dB steps. Refer to figures 66 and 67.

INPUT TRIM
+4.0 dB

Figure 66

INPUT TRIM
-2.5 dB

Figure 67

After approximately 6 seconds the Information Display returns to indicate the Source Selection and Volume Level.

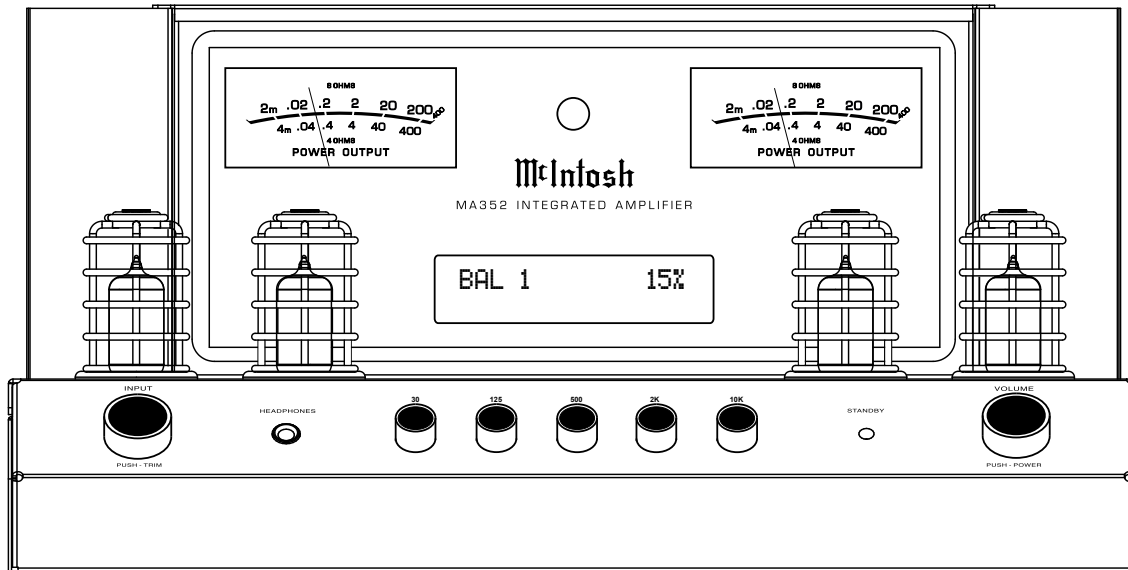

Figure 50

METER ILLUMINATION

The Meter Illumination of the McIntosh MA352 may be switched On or Off by performing the same type of operational steps as MONO/STEREO MODE on page 23:

1. Select "METER LIGHTS, On" as indicated on the Front Panel Information Display. Refer to figure 68.

METER LIGHTS
On

Figure 68

2. Switch Off the Meter Illumination by using the Front Panel Controls or Remote Control Push-buttons. Refer to figure 69.

METER LIGHTS
Off

Figure 69

After approximately 6 seconds the Information Display returns to indicate the Source Selection and Volume Level.

TUBE LIGHTS

The MA352 Vacuum Tubes Green Color Illumination may be switched On or Off by performing the same type of operational as Meter Illumination Lights ON or OFF above:

1. Select "TUBE LIGHTS, On" as indicated on the Front Panel Information Display. Refer to figure 70.

TUBE LIGHTS
On

Figure 70

2. Switch Off the TUBE Illumination by using the Front Panel Controls or Remote Control Push-buttons. Refer to figure 71.



Figure 71

After approximately 6 seconds the Information Display returns to indicate the Tube Normal Color or Green.

INFORMATION DISPLAY ILLUMINATION

The Brightness Level of MA352 Front Panel Information Display can be adjusted from bright to dim by performing the same type of operational steps for adjusting the METER ILLUMINATION:

1. Select "DISPLAY, BRIGHTNESS" as indicated on the Front Panel Information Display. Refer to figure 72.



Figure 72

2. Reduce the Brightness level by adjusting the TRIM LEVEL. Refer to figure 73.



Figure 73

After approximately 6 seconds the Information Display returns to indicate the Source Selection and Volume Level.

INFORMATION DISPLAY ACTIVITY

The Activity of MA352 Front Panel Information Display can be set to be always ON or OFF by performing the same type of operational steps for adjusting the DISPLAY ILLUMINATION:

1. Select "DISPLAY, Always On" as indicated on the Front Panel Information Display. Refer to figure 74.



Figure 74

2. Switch the Front Panel Information Display OFF by adjusting the TRIM LEVEL. Refer to figure 75.



Figure 75

After approximately 6 seconds the Information Display returns to indicate the DISPLAY ON.

Reset of the Microprocessors

In the unlikely event the controls of the MA352 stop functioning, the microprocessors can be reset by performing the following:

1. Press and hold in the Front Panel VOLUME CONTROL until the STANDBY/ON LED Indicator switches Off.
2. Then release the VOLUME CONTROL and the MA352 will switch Off.
3. When the STANDBY/ON LED is illuminated press the VOLUME CONTROL and the MA352 will resume normal operation.



Amplifier Specifications

Power Output Stereo

Minimum sine wave continuous average power output per channel, with both channels operating is:
200 watts into 8 ohm load
320 watts into 4 ohm load

Output Load Impedance

8 or 4 ohms

Rated Power Band

20Hz to 20,000Hz

Total Harmonic Distortion

0.03% maximum with both channels operating from 250 milliwatts to rated power, 20Hz to 20,000Hz

Intermodulation Distortion

0.03% maximum, if the instantaneous peak power output does not exceed twice the rated power output for any combination of frequencies from 20Hz to 20,000Hz

Dynamic Headroom

1.5dB

Wide Band Damping Factor

Greater than 200 - 8 ohm, Greater than 100 - 4 ohm

Power Guard

Less than 2% THD with up to 16dB overdrive at 1,000Hz

Frequency Response

+0, -0.5dB from 20Hz to 20,000Hz
+0, -3dB from 10Hz to 100,000Hz

Preamplifier Output Impedance

500 ohms

Sensitivity (for rated output)

High Level - 250mV unbalanced, 500mV balanced
Phono - 2.5mV

Signal To Noise Ratio (A-Weighted)

High Level - 93dB below rated output
Phono - 82dB below 5mV input

Input Impedance

High Level - 20K ohms
Phono - 47K ohms; 50pF-800pF

Preamplifier Output 2 (for rated input)

1.4V unbalanced (8V Maximun)

Maximum Input Signal

High Level - 8V unbalanced, 16V balanced
Phono - 80mV

Voltage Gain

High Level to Output 1: 44dB
High Level to Output 2: 15dB
Phono to Output 1: 84dB
Phono to Output 2: 55dB

Headphone Impedance

100 to 600 ohms

Trigger Output

12VDC, 25mA

Equalizer Controls

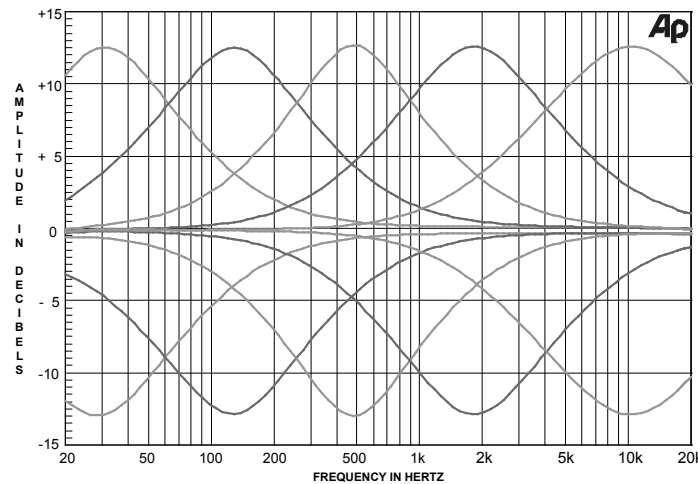

General Specifications

Power Requirements

Field AC Voltage conversion of the MA352 is not possible. The MA352 is factory configured for one of the following AC Voltages:

- 100 Volts, 50/60Hz at 7.2 amps
- 110 Volts, 50/60Hz at 6.0 amps
- 120 Volts, 50/60Hz at 6.0 amps
- 127 Volts, 50/60Hz at 6.0 amps
- 220 Volts, 50/60Hz at 3.3 amps
- 230 Volts, 50/60Hz at 3.3 amps
- 240 Volts, 50/60Hz at 3.3 amps
- Standby: Less than 0.5 watt

Note: Refer to the rear panel of the MA352 for the correct voltage.

Overall Dimensions

Width is 17-1/2 inches (44.5cm)
Height is 9-7/8 inches (25.1cm) including feet
Depth is 20-1/2 inches (52.1cm) including the Cables

Weight

66 pounds (29.9 kg) net, 75 pounds (34.0 kg) in shipping carton

Shipping Carton Dimensions

Width is 22-5/8 inches (57.5cm)
Depth is 21-7/8 inches (55.6cm)
Height is 12-7/8 inches (32.7cm)

Packing Instructions

In the event it is necessary to repack the equipment for shipment, the equipment must be packed exactly as shown below. It is very important that the four feet are attached to the bottom of the equipment. This will ensure the proper equipment location on the bottom foam pad. Failure to do this will result in shipping damage.

To protect the tubes during shipment, the Foam Insert removed from the MA352 needs to be re-inserted. Follow the unpacking instructions on pages 4-5 in the reverse order.

Use the original shipping carton and interior parts only if they are all in good serviceable condition. If a shipping carton or any of the interior part(s) are needed, please call or write Customer Service Department of McIntosh Laboratory, refer to page 2. Please see the Part List for the correct part numbers.

MA352 Packing Material List

Quantity	Part Number	Description
1	034614	Shipping carton
1	034615	Foam Top
1	034617	Foam Bottom
4	034616	Foam Middle
1	034613	Foam Insert (for protecting the Tubes during shipping)
1	241001	Warning Sheet
4	400159	10-32 x 3/4 inch screw
4	017937	Feet

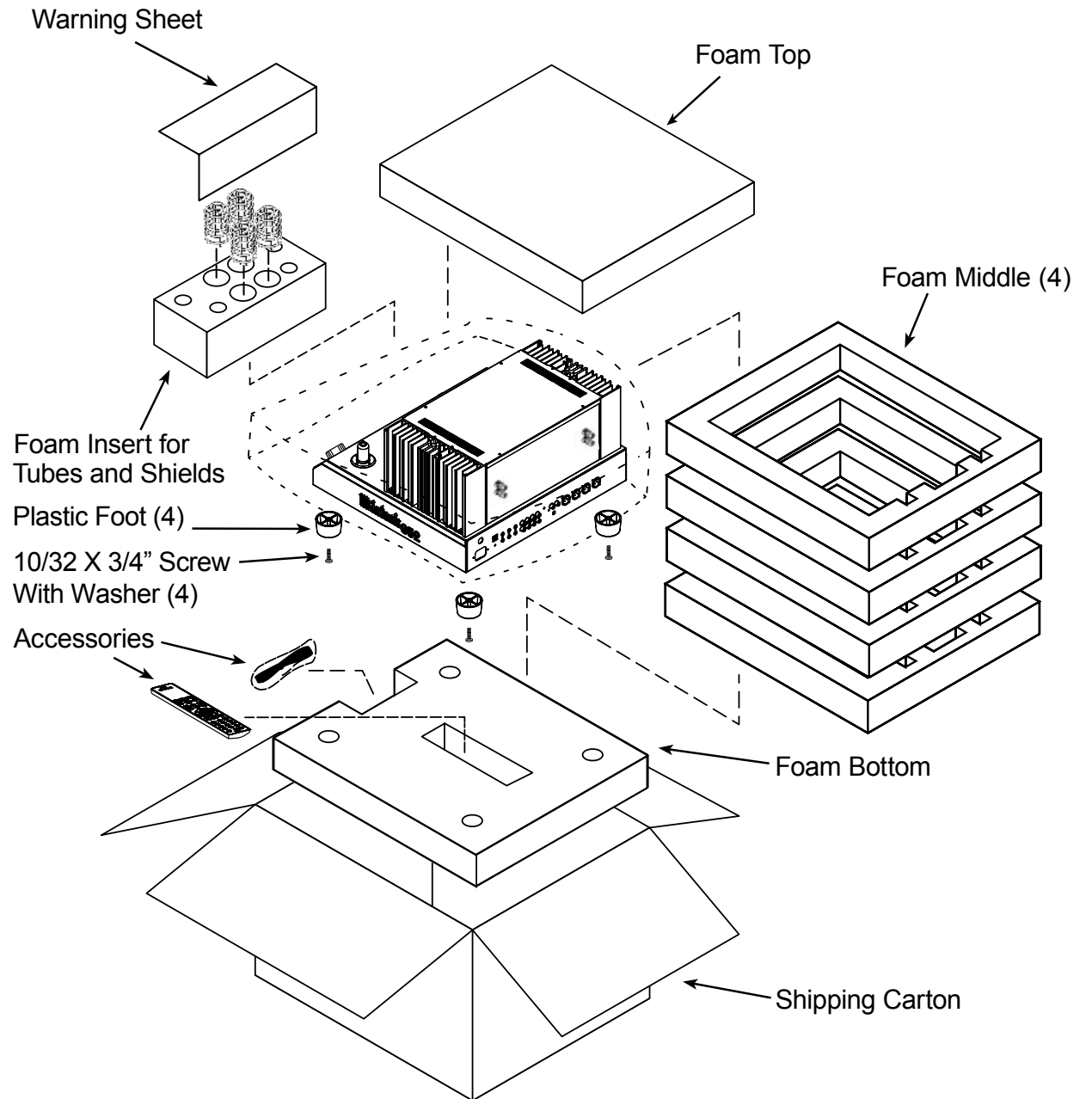



McIntosh Laboratory, Inc.
2 Chambers Street
Binghamton, NY 13903
www.mcintoshlabs.com

The continuous improvement of its products is the policy of McIntosh Laboratory Incorporated who reserve the right to improve design without notice.
Printed in the U.S.A.